

# THE WOOD GRID® SUSPENDED COFFERED CEILING SYSTEM PAINT/STAIN GUIDE

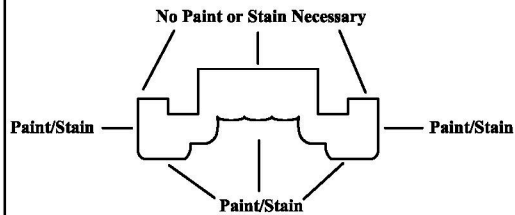

**PT 1350 WOOD GRID®  
Ceiling Moulding 3/4 x 2**

Stain shaded area on ends of cross tees with key-lock joint. Do not paint or top coat.

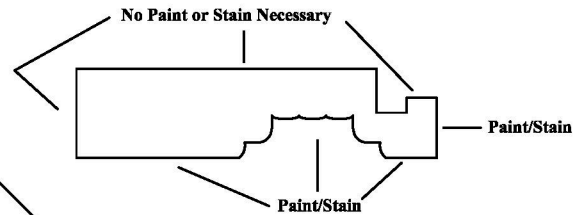
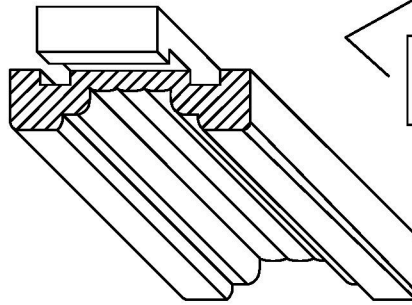

**PT 1351 Cove Band 3/4 x 3**

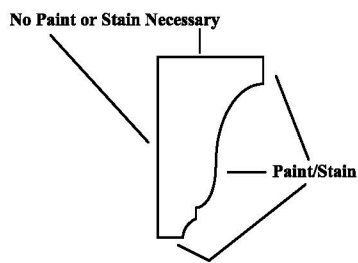

**PT 219 Panel Mold 7/8 x 1-1/2**

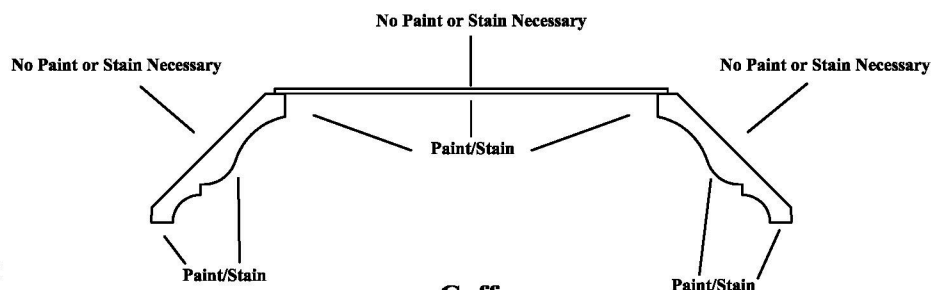

**Coffer**

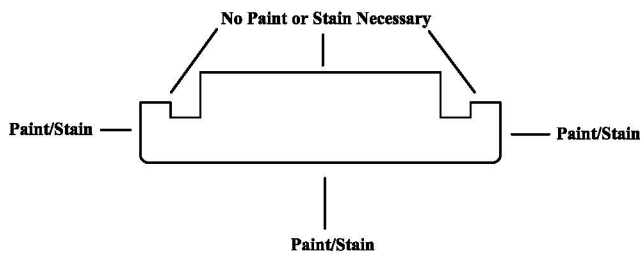

**PT 1450 WOOD GRID®  
Ceiling Moulding 3/4 x 3**

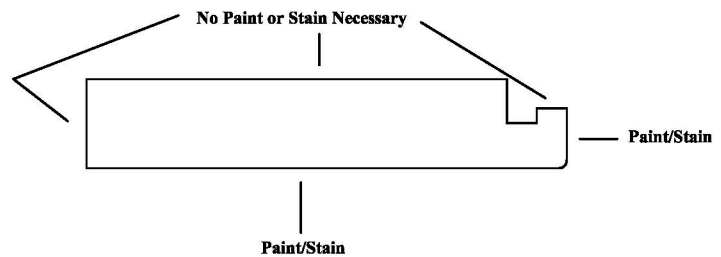

**PT 1451 Cove Band 3/4 x 4**

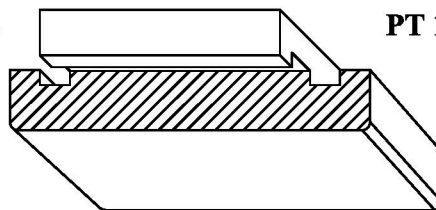

Stain shaded area on ends of cross tees with key-lock joint. Do not paint or top coat.

**MIDWESTERN WOOD PRODUCTS COMPANY**  
1500 West Jefferson, P.O. Box 434  
Morton, Illinois 61550  
Phone 309/266-9771  
FAX 309/263-2696

\*In areas with high humidity, sealing the back side of all components is recommended.