

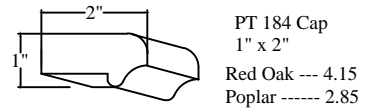

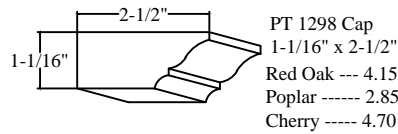

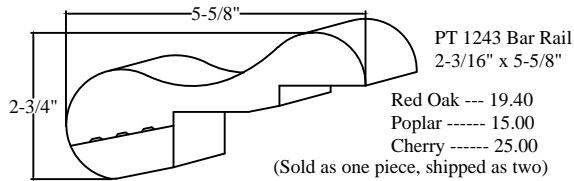

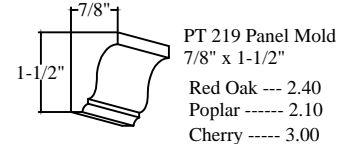

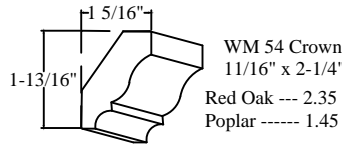
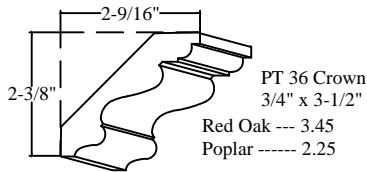
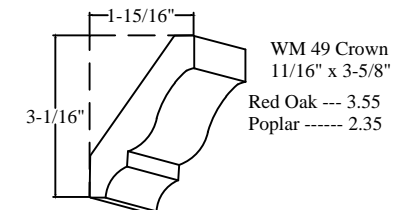
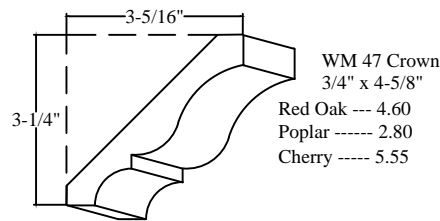
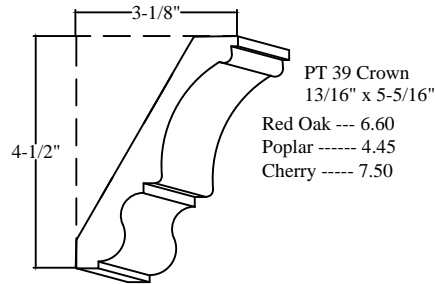
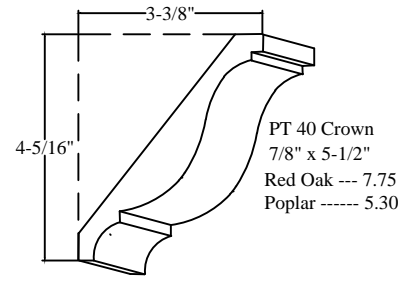
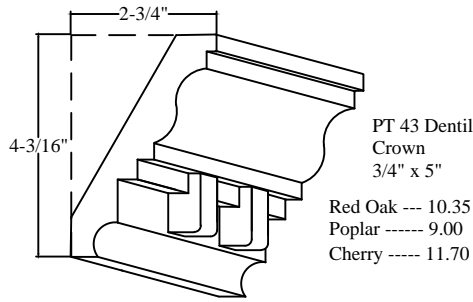
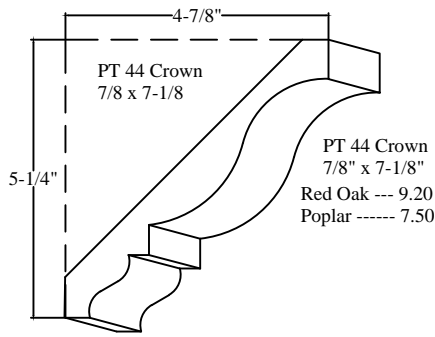
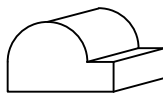





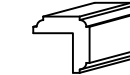

CROWNS AND MISCELLANEOUS



	Red Oak	Poplar	Cherry		Red Oak	Poplar
 PT 1465 Edge Mld. 1-5/16" x 2"	4.65	3.20	5.30	 PT 1242 Mantle Mld. 1-1/16" x 3-1/4"	4.50	2.65
 PT 182R Panel Mld. 3/4" x 1-1/8"	1.85	1.65	2.15	 WM 182NR Panel Mld. 11/16" x 1-5/8"	1.85	1.20
 PT 194R Panel Mld. 1-1/16" x 1-3/8" 1/2" or 3/4" Rabbet	2.25	1.95	2.55	 PT 400 Quarter Rnd. 3/4" x 3/4"	.90	.55
 WM 202 Outside Corner 1-1/16" x 1-1/16"	1.70	1.10	NA	 PT 920 Stop 7/16" x 1-3/8"	1.15	.75
 WM 205 Outside Corner 1-1/16" x 1-1/16"	1.70	1.10	NA	 PT 132 Astragal 1/2" x 1-1/8"	1.40	1.15
 WM 206 Outside Corner 3/4" x 3/4"	.85	.80	1.30	 PT 135 Astragal 7/16" x 3/4"	.55	.35
 PT 100 Inside Corner 11/16" x 11/16"	.60	.60	1.30	 PT 8610 Base Cap 1/2" x 3/4"	.55	.35
 PT 185 Panel Mld. 5/16" x 1-3/8"	.90	.65	1.05	 PT 409 Shelf Edge 5/8" x 1-1/16" w/ or w/o 3/4" Plow	1.35	.90
 WM 126 Shoe 1/2" x 3/4"	.55	.50	.80			