

# MIDWESTERN WOOD PRODUCTS CO.

1500 W. Jefferson, P.O. Box 434 Morton, IL. 61550

Phone# (309)266-9771 Fax# (309)263-2696

## Price List

(All prices per linear foot)

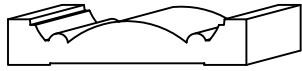

PT 1253 Casing Red Oak --- 3.96  
13/16" x 4-1/4" Poplar ----- 2.38



PT 1289 Casing Red Oak --- 3.96  
3/4" x 4-1/4" Poplar ----- 2.38  
Cherry ----- 5.15



PT 1254 Casing Red Oak --- 2.81  
3/4" x 3-1/4" Poplar ----- 1.69



PT 1292 Casing Red Oak --- 2.81  
3/4" x 3-1/4" Poplar ----- 1.69



PT 1236 Casing Red Oak --- 3.00  
3/4" x 3-1/2" Poplar ----- 1.78



PT 1291 Casing Red Oak --- 1.31  
3/8" x 3" Poplar ----- .78  
Cherry ----- 2.37



PT 445 Casing Red Oak --- 3.00  
3/4" x 3-1/2" Poplar ----- 1.78  
Cherry ----- 4.33



PT 374 Casing Red Oak --- 3.00  
13/16" x 3-1/2" Poplar ----- 1.78



PT 447 Casing Red Oak --- 2.44  
13/16" x 2-3/4" Poplar ----- 1.45  
Cherry ----- 3.52

## BASES

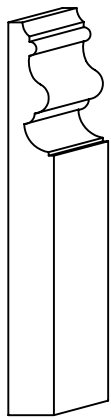

PT 737 Base Red Oak --- 7.50  
13/16" x 7" Poplar ----- 4.50

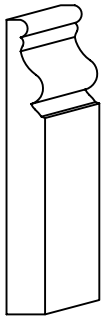

PT 736 Base Red Oak --- 4.65  
11/16" x 5-1/4" Poplar ----- 2.55

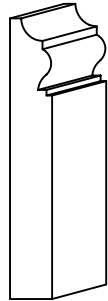

PT 733 Base Red Oak --- 4.15  
3/4" x 5" Poplar ----- 2.48  
Bending Base (any specie) --- 12.00/ft.

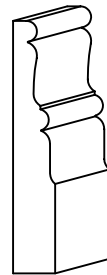

PT 730 Base Red Oak --- 3.75  
11/16" x 4-1/2" Poplar ----- 2.25  
Cherry ----- 5.42

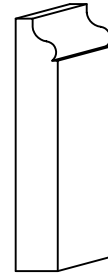

PT 620C Base Red Oak --- 3.75  
3/4" x 4-1/2" Poplar ----- 2.25

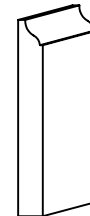

PT 520 Base Red Oak --- 1.67  
7/16" x 3-1/2" Poplar ----- 1.04

## CHAIR RAILS

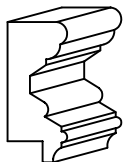

PT 426R Chair Rail Red Oak --- 3.91  
1-1/16" x 2-1/2" Poplar ----- 2.74  
3/8" or 5/8" Rabbet Cherry ----- 5.08

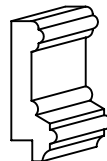

PT 410R Chair Rail Red Oak --- 2.25  
13/16" x 2-1/2" Poplar ----- 1.35  
w/ 3/8" or No Rabbet

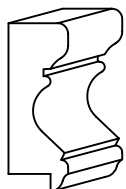

PT 437R Chair Rail Red Oak --- 4.55  
1-1/16" x 3" Poplar ----- 3.20  
with 3/4" Rabbet Cherry ----- 5.92



WM 390 Chair Rail Red Oak --- 2.25  
11/16" x 2-1/2" Poplar ----- 1.35



PT 299 NR Chair Rail Red Oak --- 2.25  
7/8" x 2-1/2" Poplar ----- 1.35

# CROWNS AND MISCELLANEOUS

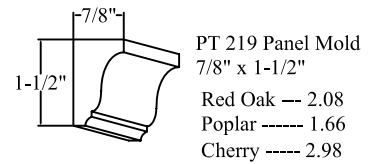
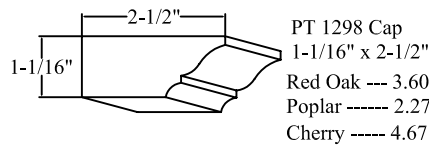
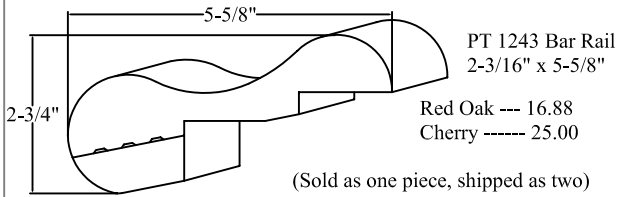
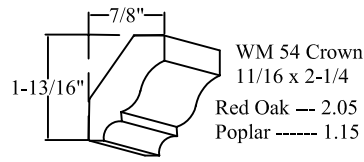
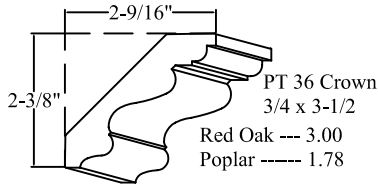
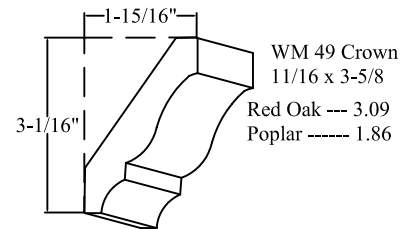
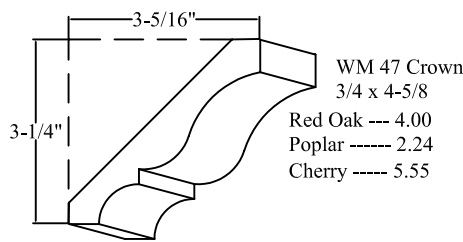
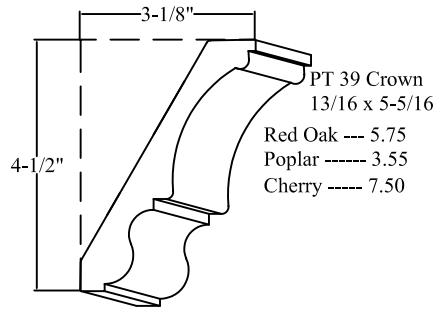
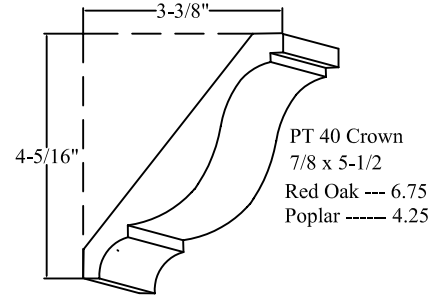
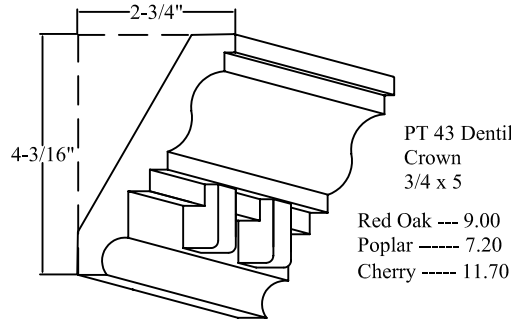
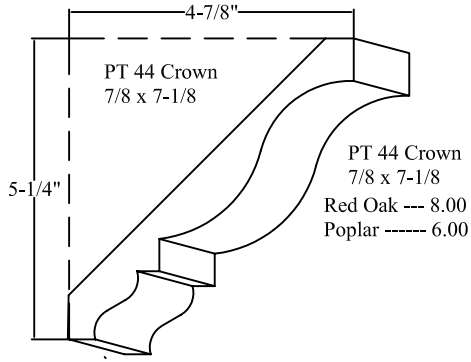

	Red Oak	Poplar	Cherry		Red Oak	Poplar
PT 1465 Edge Mld. 1-5/16" x 2"	4.06	2.56	5.28	PT 1242 Mantle Mld. 1-1/16" x 3-1/4"	3.90	2.11
PT 182R Panel Mld. 3/4" x 1-1/8"	1.62	1.30	2.11	WM 182NR Panel Mld. 11/16" x 1-5/8"	1.59	.97
PT 194R Panel Mld. 1-1/16" x 1-3/8" 1/2" or 3/4" Rabbet	1.95	1.56	2.54	PT 400 Quarter Rnd. 3/4" x 3/4"	.79	.42
PT 409 Shelf Edge 5/8" x 1-1/16"	1.17	.70	NA	PT 920 Stop 7/16" x 1-3/8"	1.00	.61
WM 206 Outside Corner 3/4" x 3/4"	.72	.63	1.29	WM 948 Stop 3/8" x 1-1/8"	.61	.37
WM 205 Outside Corner 1-1/16" x 1-1/16"	1.47	.88	NA	PT 132 Astragal 1/2" x 1-1/8"	1.22	.91
PT 100 Inside Corner 11/16" x 11/16"	.48	.48	1.29	PT 135 Astragal 7/16" x 3/4"	.49	.26
PT 185 Panel Mld. 5/16" x 1-3/8"	.78	.52	1.01	PT 8610 Base Cap 1/2" x 3/4"	.49	.26
WM 126 Shoe 1/2" x 3/4"	.43	.38	.79			